

PC (Polycarbonate)

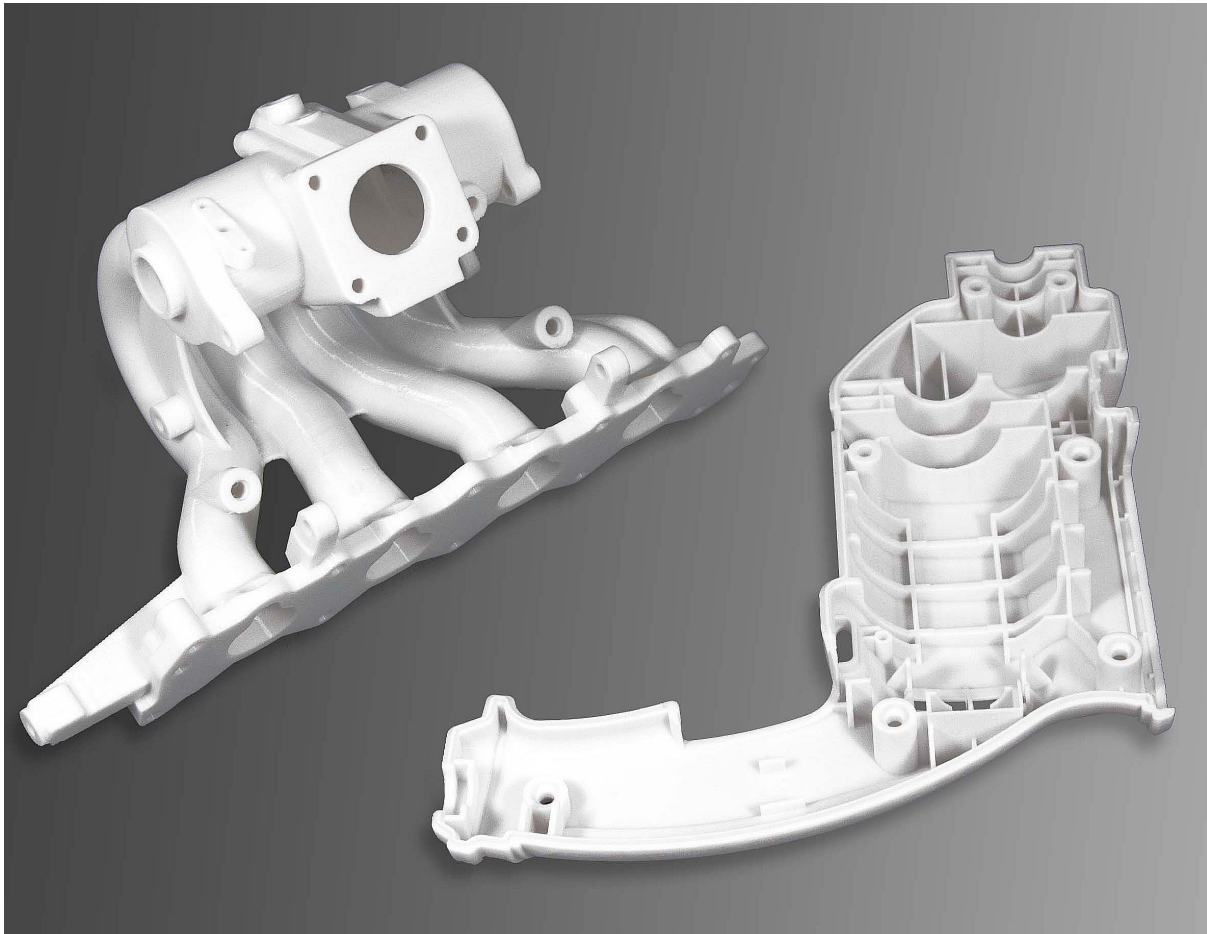

FDM Thermoplastic Filament

The information presented are typical values intended for reference and comparison purposes only. They should not be used for design specifications or quality control purposes.



Overview

PC is a polycarbonate FDM® filament that brings the attributes of this industrial plastic to 3D printing applications. PC is characterized by its high strength and impact resistance, coupled with dimensional stability and heat resistance. These attributes make it a good choice for 3D printed prototypes, parts and tools that demand higher material properties than ABS or ASA.

FDM PC is available in white, black and red.

Contents:

Ordering Information	3
Physical Properties	5
Mechanical Properties	6
UV Aging	7
Appendix	8

Ordering Information

Table 1. Printer and Support Material Compatibility

Printer	Model Tip (Slice)	Support Material	Support Tip
Fortus 450mc™	T10 (5 slice)		T12SR100 (SR-100) (5, 7, 10 slice)
	T12 (7, 10 slice)	SR-100 (soluble) (5, 7, 10 slice)	T12 (PC BASS) (7 slice)
	T16 (10 slice)	PC BASS (breakaway) (7, 10, 13 slice)	T16 (PC BASS) (10, 13 slice)
	T20 (13 slice)		
Fortus 900mc™/F900™	T12 (7, 10 slice)	SR-100 (soluble) (7, 10, 13 slice)	T12SR100 (SR-100) (7, 10, 13 slice)
	T16 (10 slice)	PC BASS (breakaway) (7, 10, 13 slice)	T12 (PC BASS) (7 slice)
	T20 (13 slice)		T16 (PC BASS) (10, 13 slice)

BASS = breakaway support system.

PC black and PC red are only available on the Fortus 450mc with the T16 model tip and SR-100 support material.

Build Sheet

Low Temperature

- 0.02 x 26 x 38 in. (0.51 x 660 x 965 mm)
- 0.02 x 16 x 18.5 in. (0.51 x 406 x 470 mm)

Table 2. PC Ordering Information

Part Number	Description
Filament Canisters^{1 2}	
355-02210	PC, 92.3 cu in. - Plus
355-08210	PC, 184 cu in. - Plus
360-50210	PC, Xtend 500 - Plus
355-70060	PC red, 92 cu in. - Plus
355-70061	PC black, 92 cu in. - Plus
310-20100	PC, 92.3 cu in. - Classic
310-20118	PC, 184 cu in. - Classic
355-03210	PC BASS, 92.3 cu in. - Plus
360-53210	PC BASS, Xtend 500 - Plus
310-30100	PC BASS, 92.3 cu in. - Classic
355-03120	SR-100 Soluble Support, 92.3 - Plus
310-31100	SR-100 Soluble Support, 92.3 - Classic
Printer Consumables	
511-10501	T10 tip
511-10301	T12 tip
511-10401	T16 tip
511-10701	T20 tip
511-10100	T12SR100 tip, 0.005, 0.007, and 0.010 in. support layer heights
325-00300	Low Temperature build sheet, 0.02 x 26 x 38 in. (0.51 x 660 x 965 mm)
325-00100	Low Temperature build sheet, 0.02 x 16 x 18.5 in. (0.51 x 406 x 470 mm)
310-00100	Low Temperature build sheet, 0.03 x 16 x 18.5 in. (0.76 x 406 x 470 mm)
355-00100	Low Temperature build sheet, 0.02 x 14 x 16.5 in. (0.51 x 355 x 420 mm)

¹ Classic canisters are compatible with all Fortus 900mc printers prior to s/n L502.

² Plus canisters are compatible with all Fortus 450mc, all Stratasys F900, and Fortus 900mc printers s/n L502 and up.

Physical Properties

Values are measured as printed. XY, XZ, and ZX orientations were tested. For full details refer to the [Stratasys Materials Test Report](#) (immediate download upon clicking the link). DSC and TMA curves can be found in the Appendix.

Table 3. PC Physical Properties

Property	Test Method	Typical Values	
		XY	XZ/ZX
HDT @ 66 psi ¹	ASTM D648 Method B		143.7 C (290.7 F)
HDT @ 264 psi ¹	ASTM D648 Method B		142.2 C (288.0 F)
Tg	ASTM D7426 Inflection Point		142.53 C (288.55 F)
Mean CTE	ASTM E831 (-50 °C to 120 °C)	-	49.19 µm/[m*°C] (27.33 µin/[in*°F])
	ASTM E831 (-50 vC to 30 °C)	51.64 µm/[m*°C] (28.69 µin/[in*°F])	-
	ASTM E831 (30 °C to 75 °C)	35.79 µm/[m*°C] (19.88 µin/[in*°F])	-
	ASTM E831 (75 °C to 130 °C)	11.51 µm/[m*°C] (6.394 µin/[in*°F])	-
Volume Resistivity	ASTM D257		> 6.78*10 ¹⁴ Ω*cm
Dielectric Constant	ASTM D150 1 kHz test condition	2.66	2.84
	ASTM D150 2 MHz test condition	2.53	2.69
Dissipation Factor	ASTM D150 1 kHz test condition	-0.002	-0.002
	ASTM D150 2 MHz test condition	0.003	0.008
Thermal Conductivity	ASTM E1952 @0C		0.2802 W/m*K 0.1619 BTU/(hr*ft*F)
Thermal Conductivity	ASTM E1952 @30C		0.2845 W/m*K 0.1644 BTU/(hr*ft*F)
Thermal Conductivity	ASTM E1952 @60C		0.2902 W/m*K 0.1677 BTU/(hr*ft*F)
Thermal Conductivity	ASTM E1952 @90C		0.2888 W/m*K 0.1669 BTU/(hr*ft*F)
Thermal Diffusivity	ASTM E1952 @0C		0.189 mm ² /s 2.93*10 ⁻⁴ in ² /s
Thermal Diffusivity	ASTM E1952 @30C		0.171 mm ² /s 2.65*10 ⁻⁴ in ² /s
Thermal Diffusivity	ASTM E1952 @60C		0.159 mm ² /s 2.46*10 ⁻⁴ in ² /s
Thermal Diffusivity	ASTM E1952 @90C		0.146 mm ² /s 2.26*10 ⁻⁴ in ² /s
Specific Gravity	ASTM D792 @23 °C		1.20
UL Flammability	ANSI/UL 746B		HB - Blue Card E345258

¹ HDT values reflect molded values, not as-printed.

Mechanical Properties

PC samples were printed with 0.010 in. (0.254 mm) layer heights on the F900. For the full test procedure please see the [Stratasys Materials Test Procedure](#) (immediate download upon clicking the link).

Print Orientation

Parts created using FDM are anisotropic as a result of the printing process. Below is a reference of the different orientations used to characterize the material.

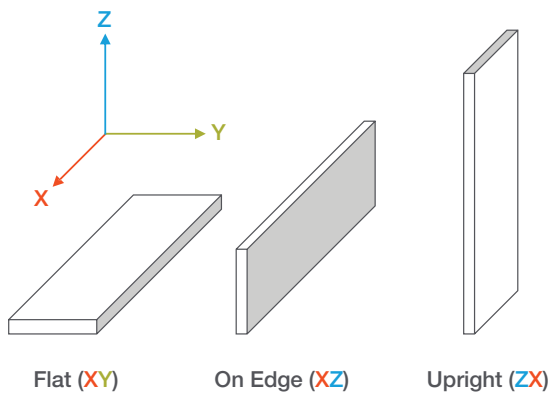

Tensile Curves

Due to the anisotropic nature of FDM, tensile curves look different depending on orientation. Below is a guide of the two types of curves seen when printing tensile samples and what reported values mean.

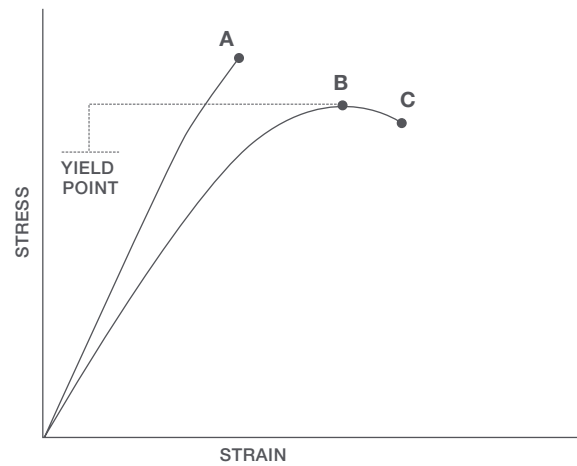

- A = Tensile at break, elongation at break (no yield point)
- B = Tensile at yield, elongation at yield
- C = Tensile at break, elongation at break

Table 4. PC Mechanical Properties (F900 - T16 Tip)

		XZ Orientation ¹	ZX Orientation ¹
Tensile Properties: ASTM D638			
Yield Strength	MPa	57.9 (1.6)	No yield
	psi	8390 (240)	No yield
Elongation @ Yield	%	4.9 (0.12)	No yield
Strength @ Break	MPa	57.3 (1.6)	35.5 (9.0)
	psi	8310 (240)	5150 (1300)
Elongation @ Break	%	5.2 (0.38)	2.0 (0.63)
Modulus (Elastic)	GPa	2.25 (0.050)	2.13 (0.11)
	ksi	327 (7.3)	310 (16)
Flexural Properties: ASTM D790, Procedure A			
Strength @ Break	MPa	No break	75.0 (5.4)
	psi	No break	10900 (780)
Strength @ 5% Strain	MPa	90.0 (1.7)	-
	psi	13100 (240)	-
Strain @ Break	%	No break	4.58 (0.41)
Modulus	GPa	2.15 (0.042)	1.88 (0.071)
	ksi	312 (6.1)	273 (10)
Compression Properties: ASTM D695			
Yield Strength	MPa	244 (13)	290 (19)
	psi	35400 (1900)	42100 (2800)
Modulus	GPa	1.95 (0.051)	2.11 (0.090)
	ksi	283 (7.4)	306 (13)
Impact Properties: ASTM D256, ASTM D4812			
Notched	J/m	76.8 (11)	26.9 (7.7)
	ft*lb/in.	1.44 (0.21)	0.503 (0.14)
Unnotched	J/m	761 (110)	233 (70)
	ft*lb/in.	14.2 (2.0)	4.36 (1.3)

¹ Values in parentheses are standard deviations.

UV Aging

PC was tested before and after UV exposure. Ten ASTM D638 upright (ZX) dogbones were tested in tensile after UV exposure and an additional ten ASTM D638 ZX dogbones were the control (no UV exposure). The UV exposed samples were cycled in the QUV chamber per ASTM G154 (Standard Practice for Operating Fluorescent UV Light Apparatus for Exposure of Nonmetallic Materials) for 1,000 hours, alternating for eight hours at 60 °C (140 °F) and 4 hours at 50 °C (122 °F) with humidity and condensation. The increase in stress at break is from the control samples. For more information see the Impact of UV Exposure on FDM Materials white paper.

Table 5. PC UV Exposure Test Results

Material	Conditioning	Yield Strength		Stress at Break		Elongation at break (%)	Increase in Stress at Break (%)	Modulus	
		(psi)	(MPa)	(psi)	(MPa)			(ksi)	(GPa)
PC	No UV Exposure	6370	43.9	5940	40.9	3.0		258	1.78
	UV Exposure	4230	29.2	4200	29.0	1.6	-29.2%	289	1.99

PC coupons were built on the Fortus F900 using the T16 tip.

Appendix

Validated Materials

Stratasys Validated Materials are developed by Stratasys or a third-party provider, meet Stratasys quality standards, and have received basic reliability testing for use with Stratasys FDM printer. For test procedures refer to the [Stratasys Materials Test Report](#) (immediate download upon clicking the link).

Table 6. Mechanical Properties of PC Black, Fortus 450mc, T16

		XZ Orientation	ZX Orientation
Tensile Properties: ASTM D638			
Yield Strength	MPa	64.6 (0.44)	43 (5.1)
	psi	9370 (63)	6230 (740)
Elongation @ Yield	%	5.3 (0.040)	2.4 (0.36)
Strength @ Break	MPa	61.0 (2.3)	44.5 (5.8)
	psi	8840 (340)	6460 (840)
Elongation @ Break	%	6.4 (0.58)	2.5 (0.39)
Modulus (Elastic)	GPa	1.93 (0.018)	2.01 (0.034)
	ksi	280 (2.6)	291 (4.9)

Table 7. Mechanical Properties of PC Red, Fortus 450mc, T16

		XZ Orientation	ZX Orientation
Tensile Properties: ASTM D638			
Yield Strength	MPa	62.5 (0.67)	37.1 (2.3)
	psi	9060 (98)	5380 (330)
Elongation @ Yield	%	4.8 (0.2)	1.9 (0.13)
Strength @ Break	MPa	61.7 (0.97)	36.9 (2.4)
	psi	8950 (140)	5350 (350)
Elongation @ Break	%	4.9 (0.24)	1.9 (0.13)
Modulus (Elastic)	GPa	1.95 (0.021)	2.07 (0.024)
	ksi	282 (3.0)	301 (3.5)

Figure 1. 2nd heating scan DSC data for the PC Flat (XY) sample.

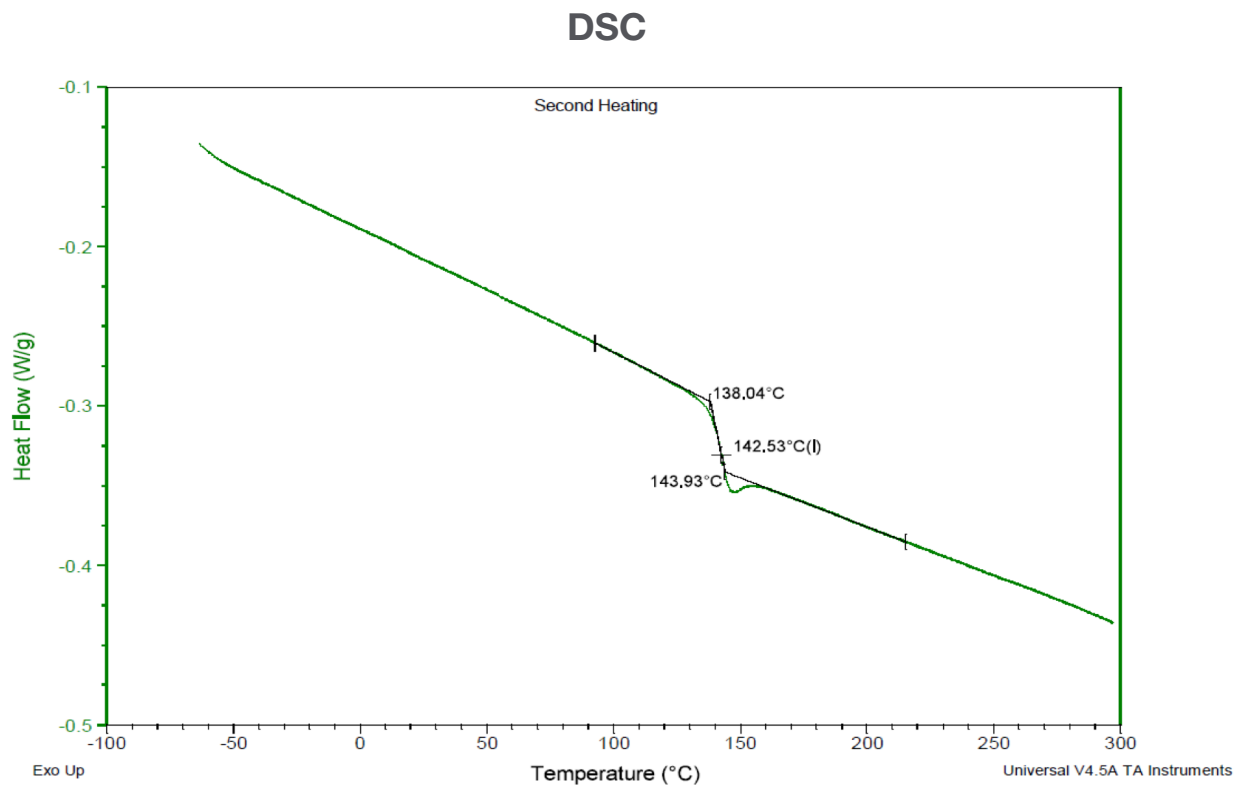

Figure 2. Dimension change data as a function of temperature for the PC Flat (XY) sample.

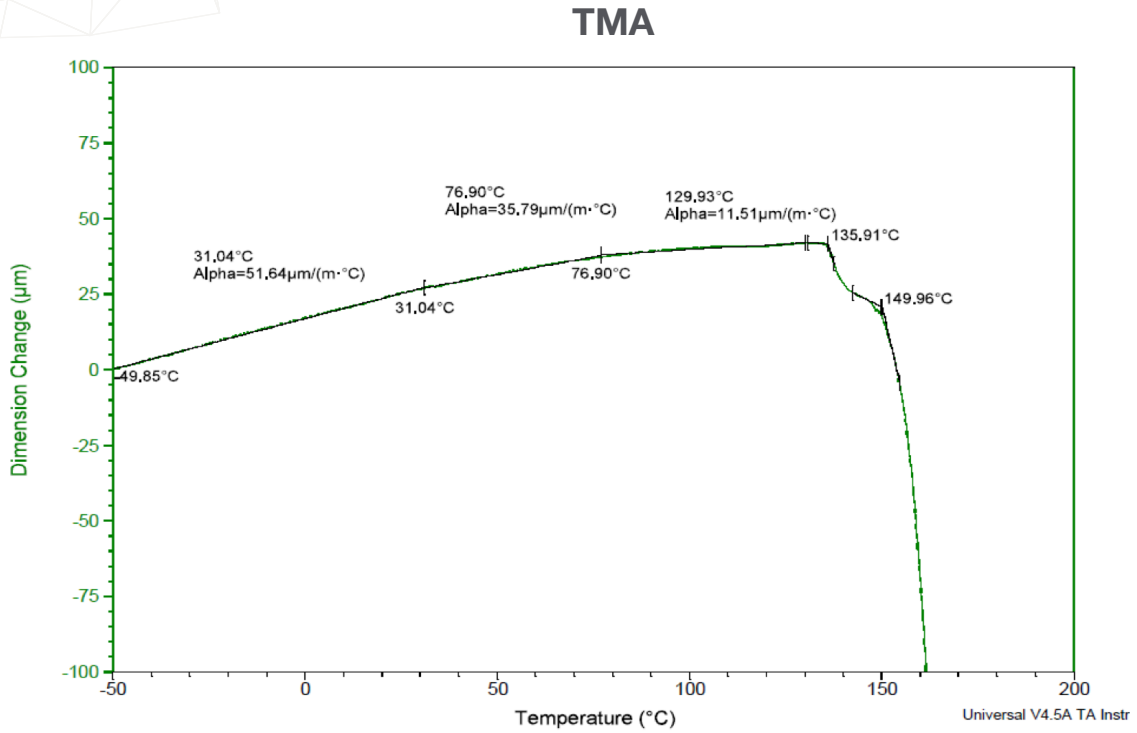

Figure 3. Dimension change data as a function of temperature for the PC On Edge (XZ) sample.

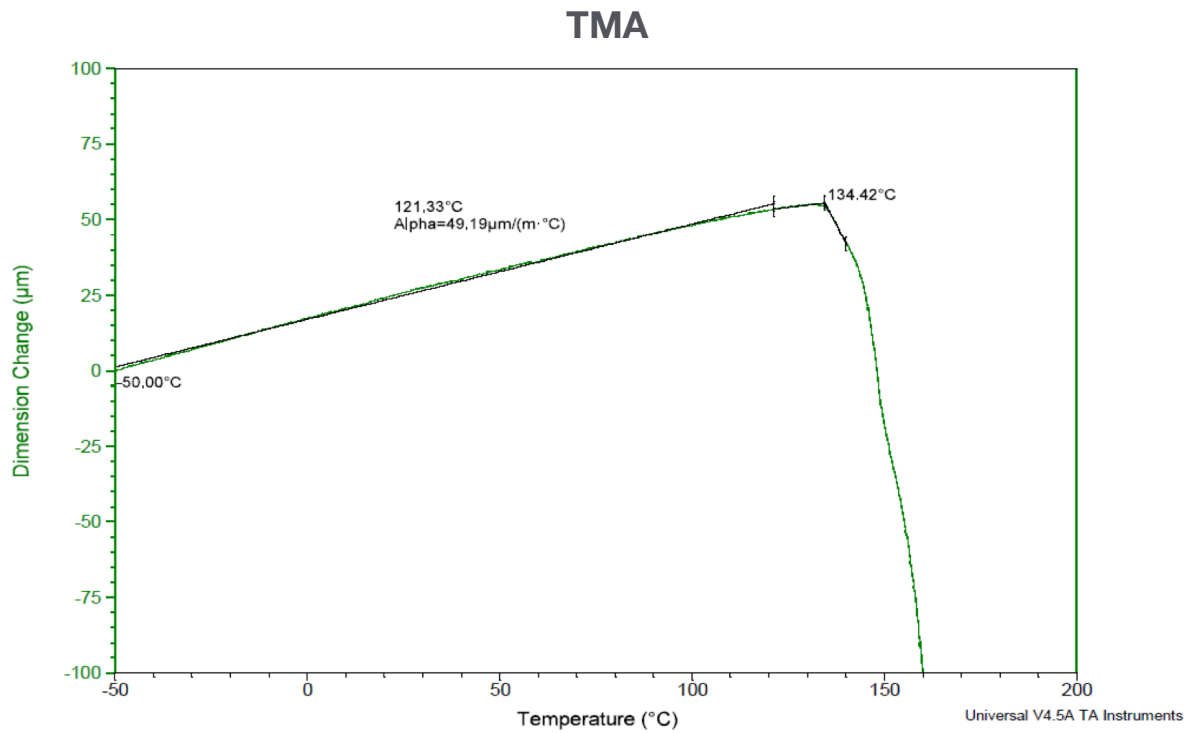
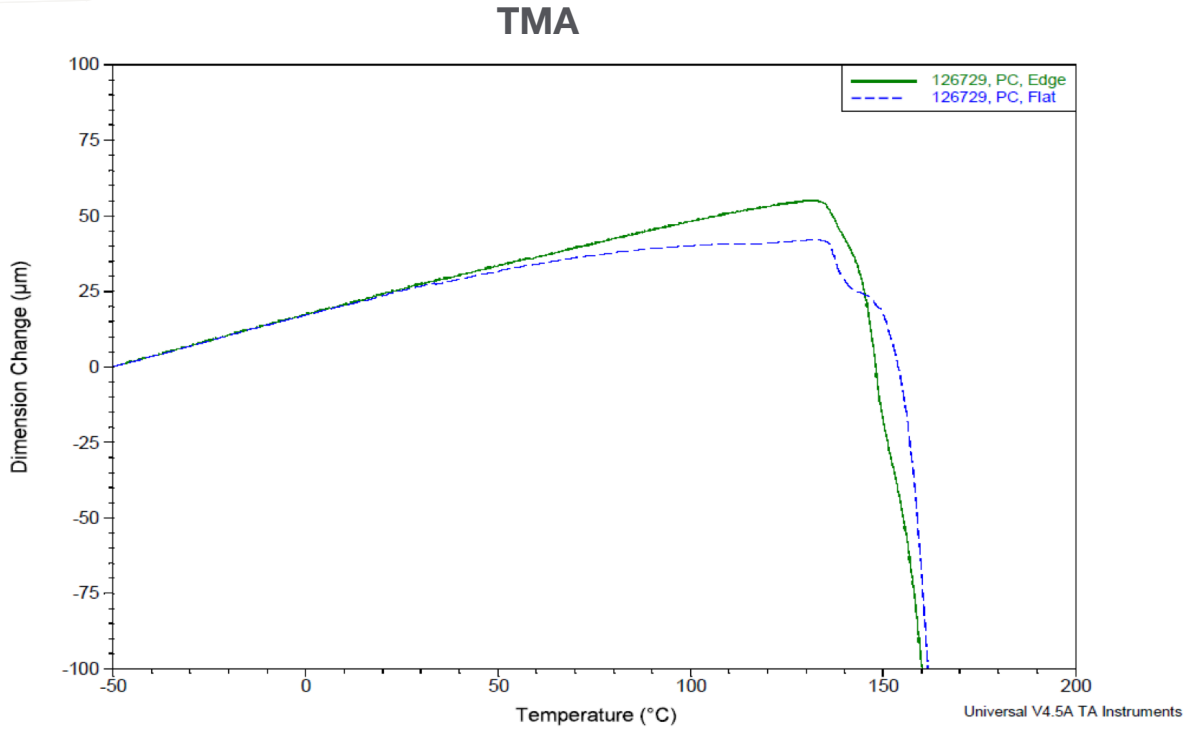

Figure 4. Overlay of the dimension change data for the Flat (XY) and On Edge (XZ) PC samples.



USA - Headquarters
 7665 Commerce Way
 Eden Prairie, MN 55344, USA
 +1 952 937 3000

ISRAEL - Headquarters
 1 Holtzman St., Science Park
 PO Box 2496
 Rehovot 76124, Israel
 +972 74 745 4000

stratasys.com
 ISO 9001:2015 Certified

EMEA
 Airport Boulevard B 120
 77836 Rheinmünster, Germany
 +49 7229 7772 0

ASIA PACIFIC
 7th Floor, C-BONS International Center
 108 Wai Yip Street Kwun Tong Kowloon
 Hong Kong, China
 + 852 3944 8888



GET IN TOUCH.
www.stratasys.com/contact-us/locations

